

BATCH CONTROLLER

WITH ONE STAGE CONTROL



Features

- Large display shows preset value and running batch value simultaneously.
- Self-learning overrun correction.
- Easy operation to enter a batch value and to control the process.
- Count-up and count-down function available.
- Selectable on-screen engineering units; volumetric or mass.
- Ability to process all types of flowmeter signals.
- Operational temperature -40°C up to +80°C (-40°F up to 178°F).
- Rugged aluminum field mount enclosure IP67/NEMA4X.
- Intrinsically Safe
Ex II 1 GD EEx ia IIC T4 T100°C.
- Explosion/flame proof Ex II 2 GD EEx d IIB T5.
- LED backlight option.
- Loop or battery powered, 8 - 24V AC/DC or 115 - 230V AC power supply.
- Sensor supply 3.2 / 8.2 / 12 / 24V DC.

Signal output

- One control output for one-stage batching.

Signal input

Flow

- Reed-switch.
- NAMUR.
- NPN/PNP pulse.
- Sine wave (coil).
- Active pulse signals.
- (0)4 - 20mA.
- 0 - 10V DC.

Applications

- For batching small up to very large quantities. Single or repeating batches. Alternative more sophisticated models: F130 - F131, F136 and 300 series.

General information

Introduction

The F030 is a straight forward but basic Batch Controller. The operator can enter a batch quantity easily or execute repeating batches. During the batch, the preset value is displayed as well as the batched (or remaining) quantity and the units of measurement. The automatic self-learning overrun correction will ensure an accurate result each batch again. A wide selection of options further enhance this models capabilities, including Intrinsic Safety.

Display

The display has large 17mm (0.67") and 8mm (0.31") digits which are used to display the batched quantity and the preset value simultaneously. On-screen engineering units are easily configured from a comprehensive selection. A seven digit resettable "day total" is available as well as an eleven digit non-resettable accumulated total. All are backed-up in EEPROM memory every minute. A smart display update function achieves a readable display even at -40°C / -40°F.

Backlight

For those applications where readability during day and night is an issue, a bi-color backlight is available. The background color green or amber and the intensity can be adjusted from the keyboard. The display is a transfective type, which means that a high contrast reading is guaranteed in full sunlight as well as during the night. This backlight option is available Intrinsically Safe.

Configuration

All configuration settings are accessed via a simple operator menu which can be pass-code protected. Each setting is clearly indicated with an alphanumeric description, therefore avoiding confusing abbreviations. Once familiar with one F-series product, you will be able to program all models in the series without a manual. All settings are safely stored in EEPROM memory in the event of sudden power failure.

Control output

One output is available for one stage control of smaller batchvolumes. The output signal can be a passive NPN or an active PNP transistor, or an isolated electro-mechanical relay.

Signal input

The F030 will accept most pulse and analog input signals for flow or mass flow measurement. The input signal type can be selected by the user in the configuration menu without having to adjust any sensitive mechanical dip-switches, jumpers or trimmers. The analog input version is even available as 4 - 20mA input loop powered display.

Power supply

Several power supply options are available to power the F030 and sensor. A battery powered version with a long life lithium battery which will last up to five years. For analog sensors, a 4 - 20mA loop powered version is available as well. A real sensor supply is offered with the 24V AC / DC or 115 - 230V AC power supply option.

Hazardous areas

For hazardous area applications, this model has been ATEX certified Intrinsically Safe $\text{Ex II 1 GD EEx ia IIC T4 T100}^\circ\text{C}$ with an allowed operational temperature of -40°C to +70°C (-40°F to +158°F). IECEx, CSA and FM certification is expected to be available in autumn 2008. A flame proof enclosure with ATEX certification offers the rating $\text{Ex II 2 GD EEx d IIB T5}$.

Enclosures

Various types of enclosures can be selected, all ATEX approved. As standard the F030 is supplied in an GRP panel mount enclosure. Most popular is our aluminum field mount enclosure with IP67 / NEMA 4X rating. Both European or U.S. cable gland entry threads are available.

Overview application F030

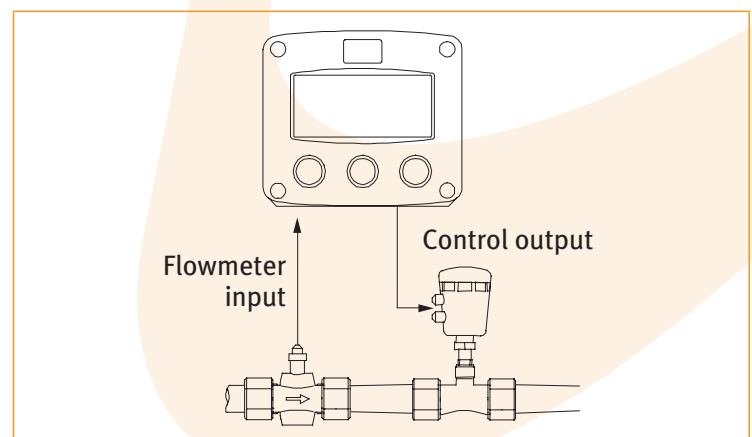

Dimensions enclosures Aluminum & GRP panel mount enclosure

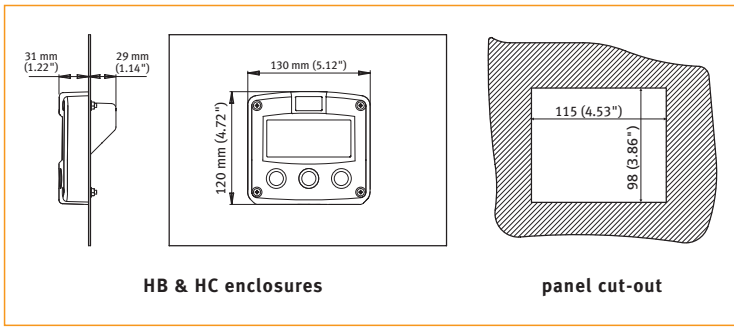

Aluminum & GRP field / wall mount enclosures

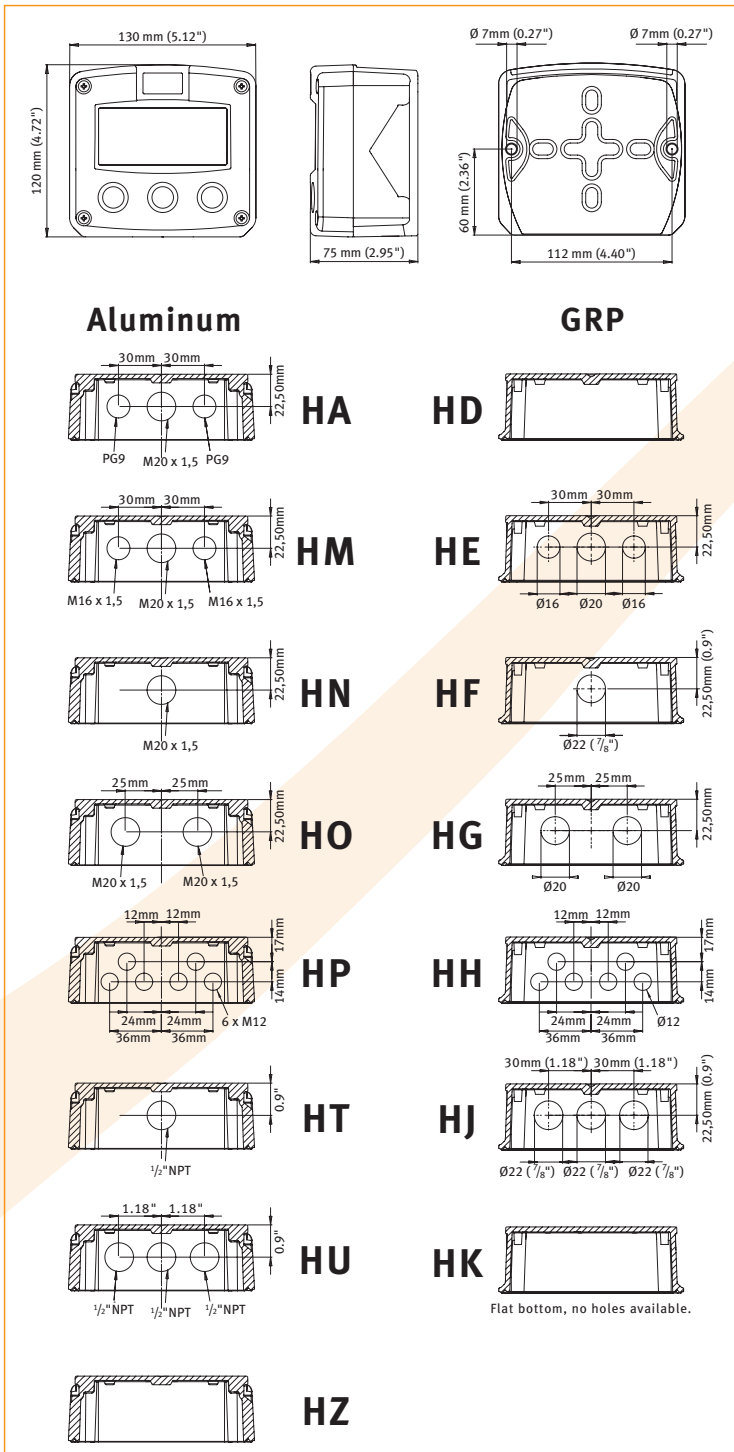

Terminal connections power supply PB/PC - PD - PL - PX

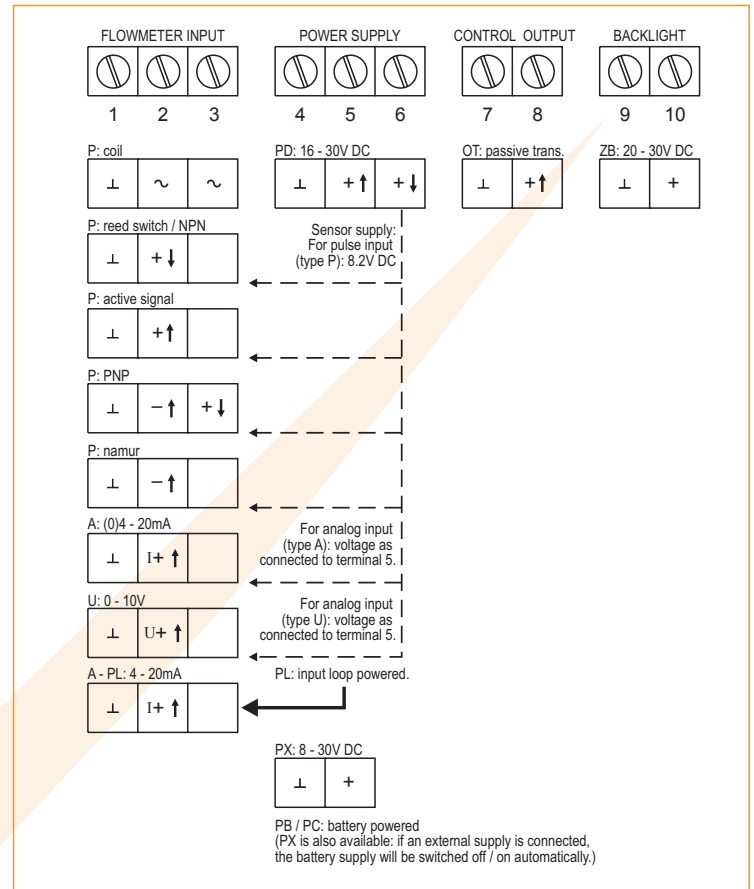

Terminal connections power supply PF - PM

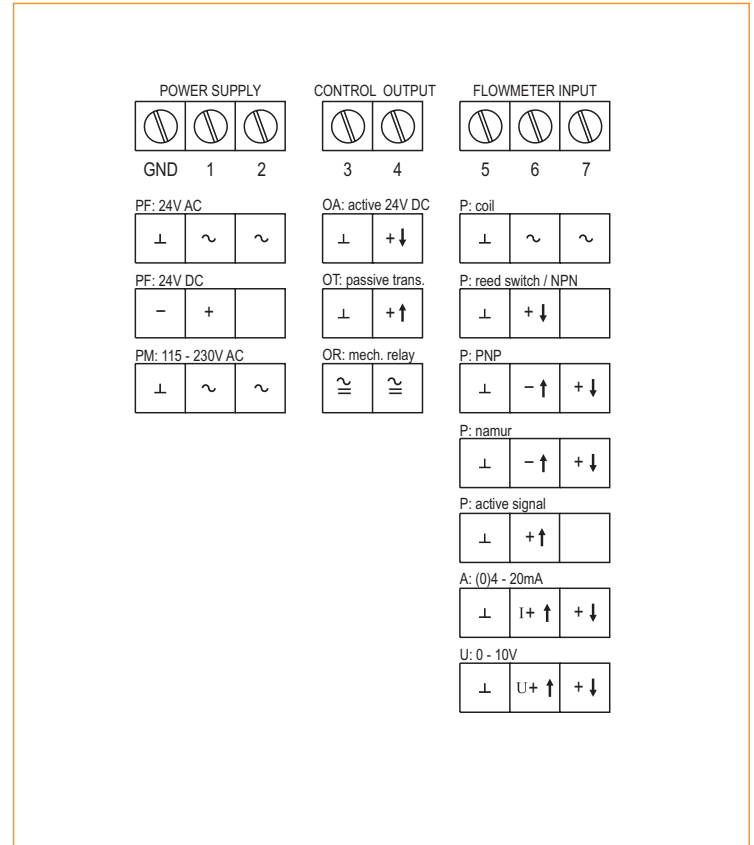

Typical wiring diagram Fo30-P-OT-PB-(PX)-(ZB)

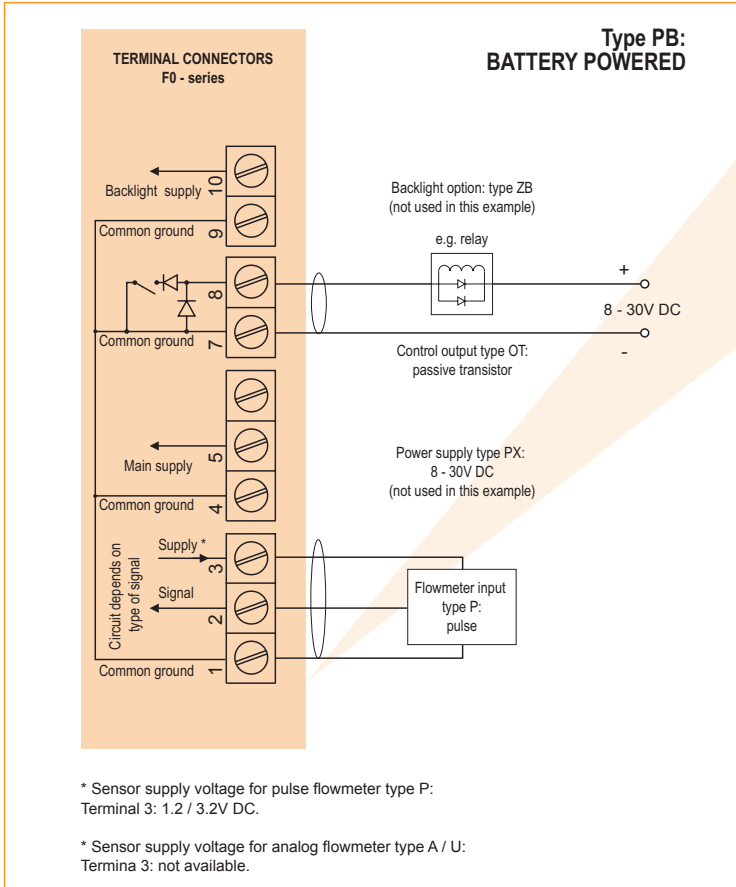

Typical wiring diagram Fo30-A-OT-PX-ZB

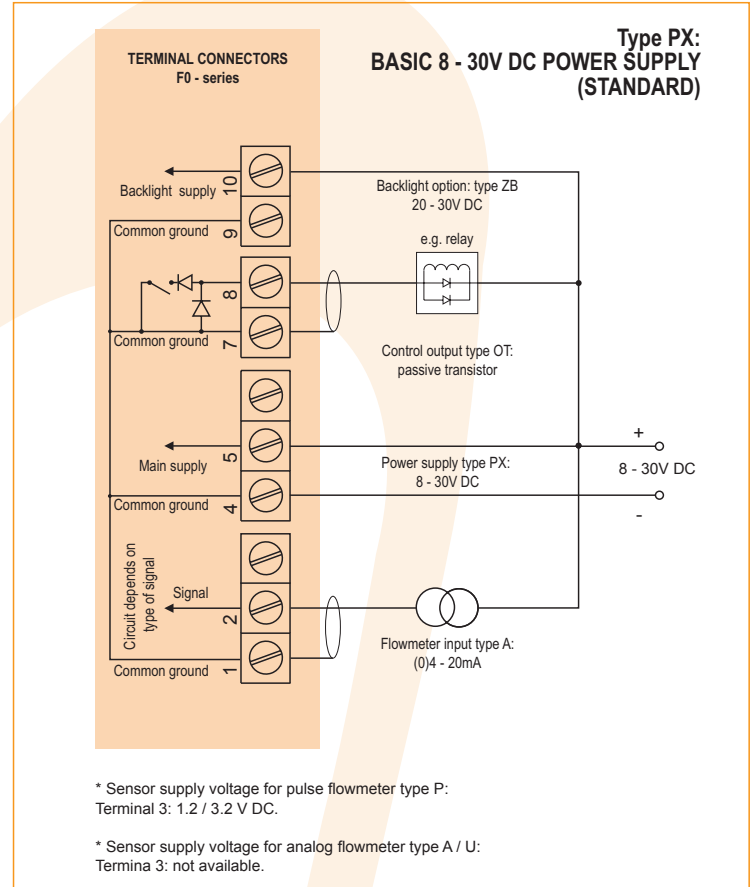

Typical wiring diagram Fo30-A-OT-PL-(ZB)

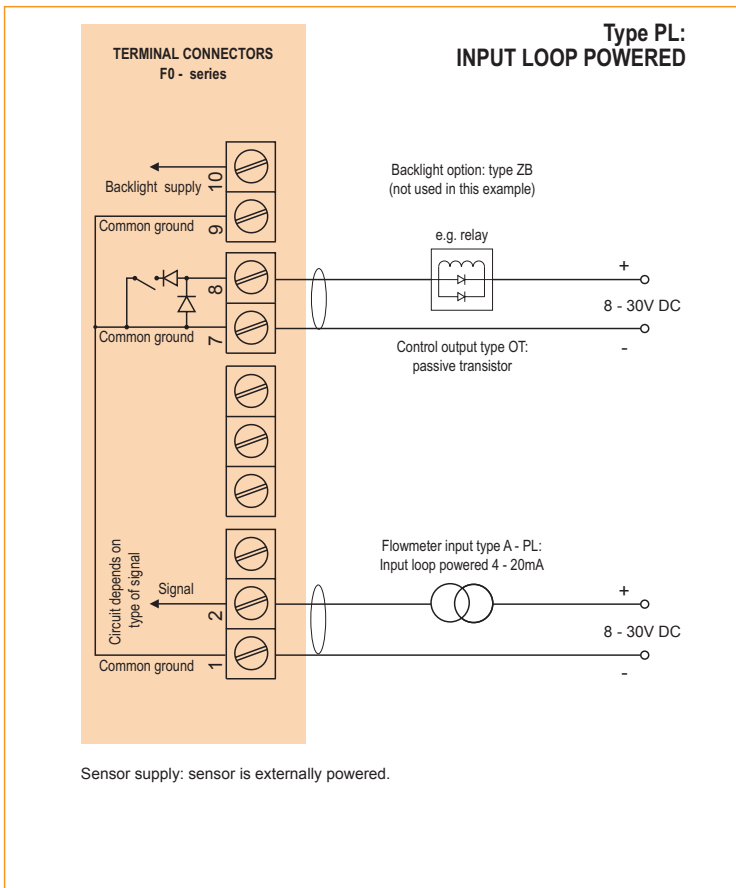

Typical wiring diagram Fo30-P-OT-PD-ZB

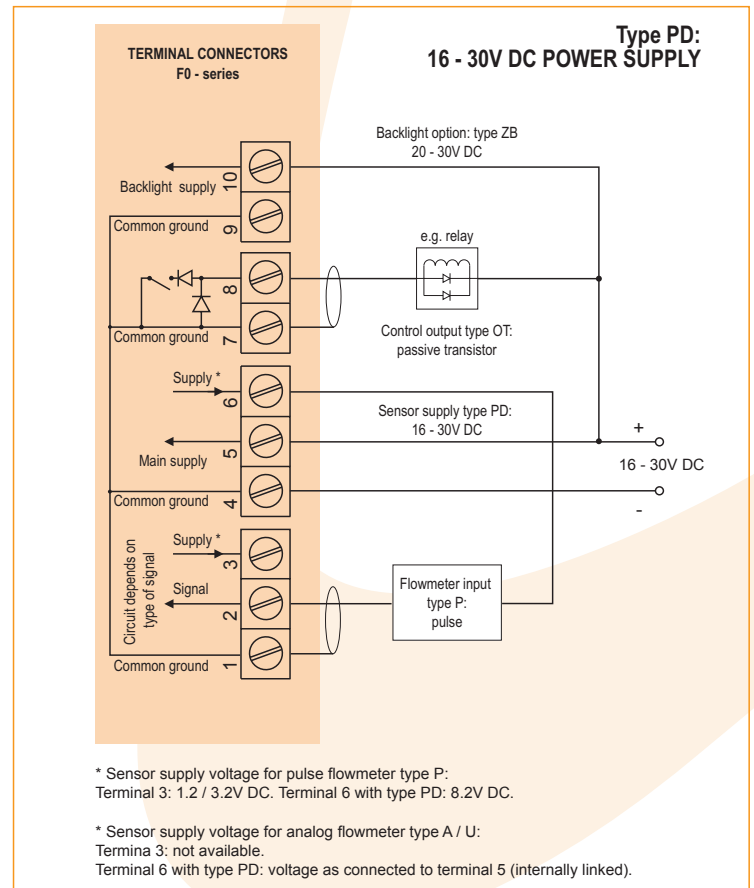

Typical wiring diagram F030-P-OA-PF-ZB

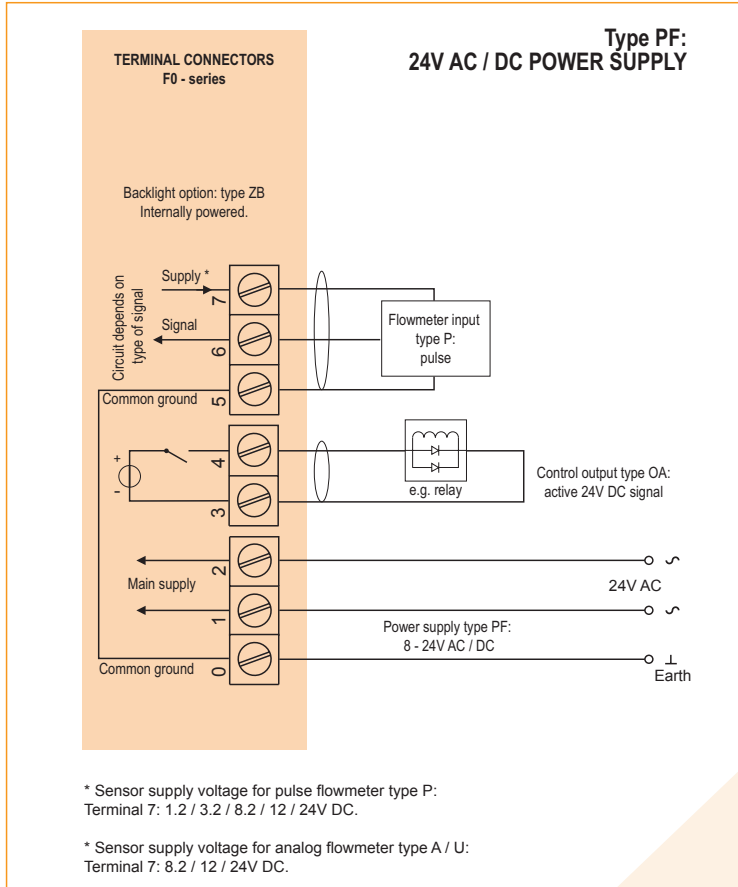

Typical wiring diagram F030-A-OR-PF-ZB

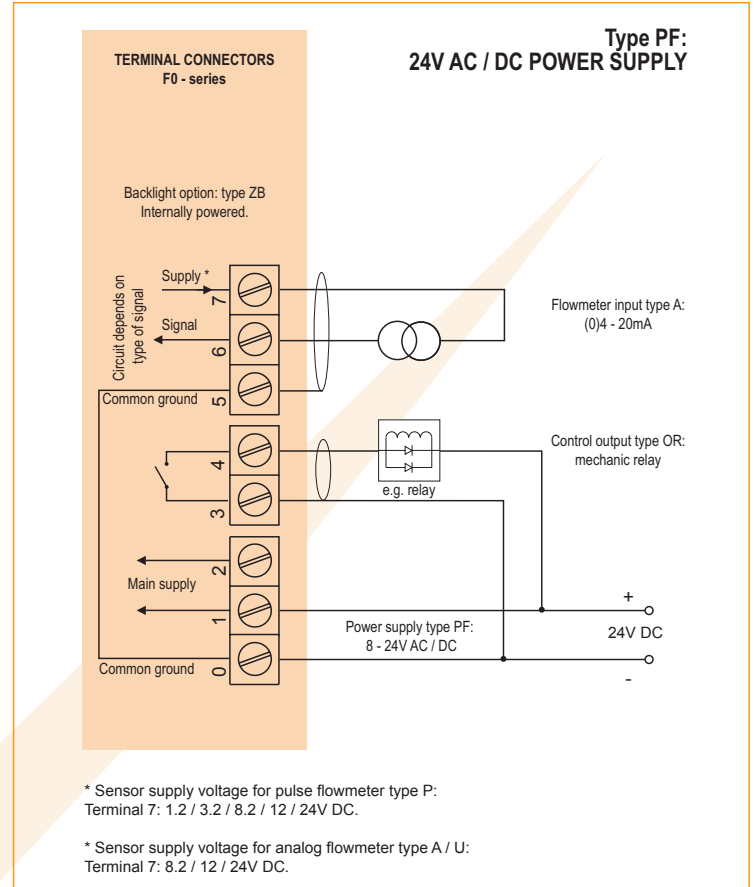

Typical wiring diagram F030-A-OA-PM-ZB

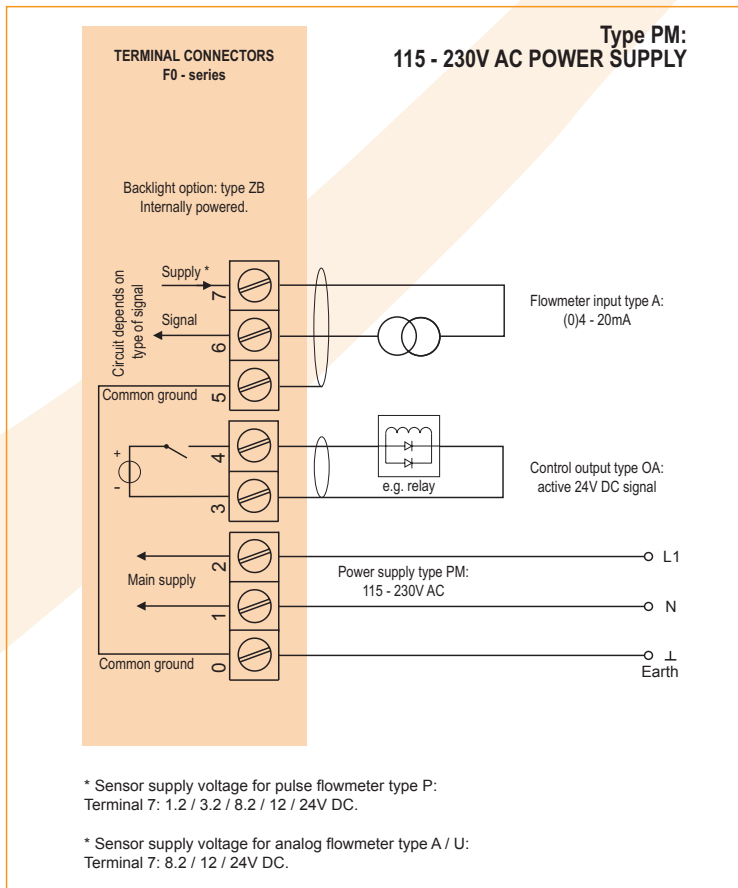

Typical wiring diagram F030-P-OR-PM-ZB

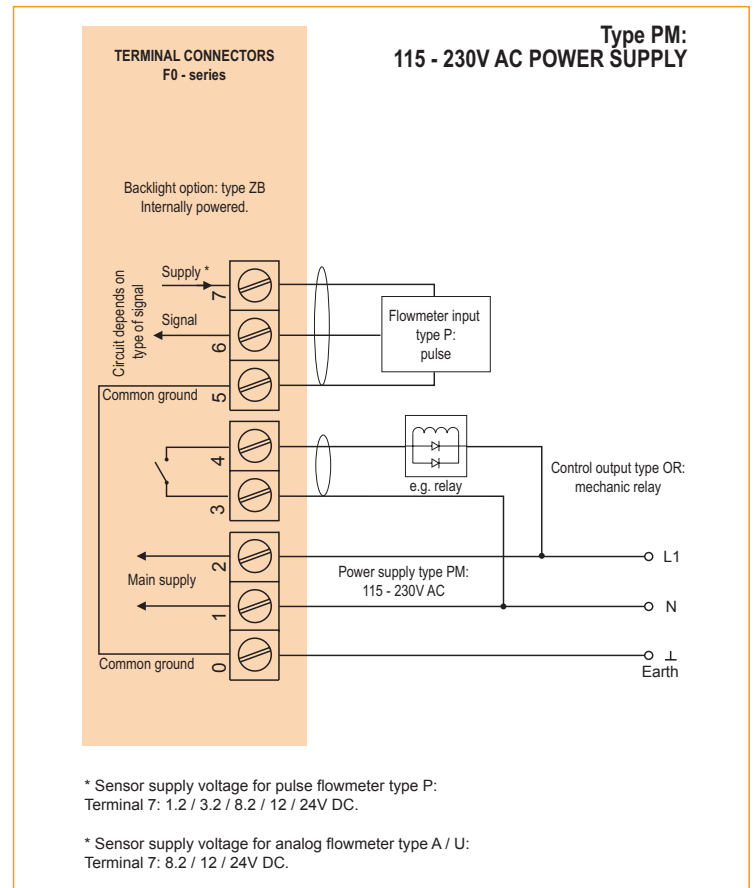

Hazardous area applications

The F030-XI has been ATEX approved by KEMA for use in Intrinsically Safe applications. It is approved according to Ex II 1 GD EEx ia IIC T4 T100°C for gas and dust applications with an operational temperature range of -40°C to +70°C (-40°F to +158°F). IECEX, CSA and FM approvals are expected to become available in autumn 2008.

It is allowed to connect up to four I.S. power supplies to power the unit, sensor, control output and backlight. The F030-PD-XI offers a 8.2V DC sensor supply to power e.g. a Namur sensor or the input voltage to power an analog sensor. An ATEX approved flame proof enclosure with rating Ex II 2 GD EEx d IIB T5 is available as well. Please contact your supplier for further details.

Certificate of conformity KEMA 05ATEX1168 X

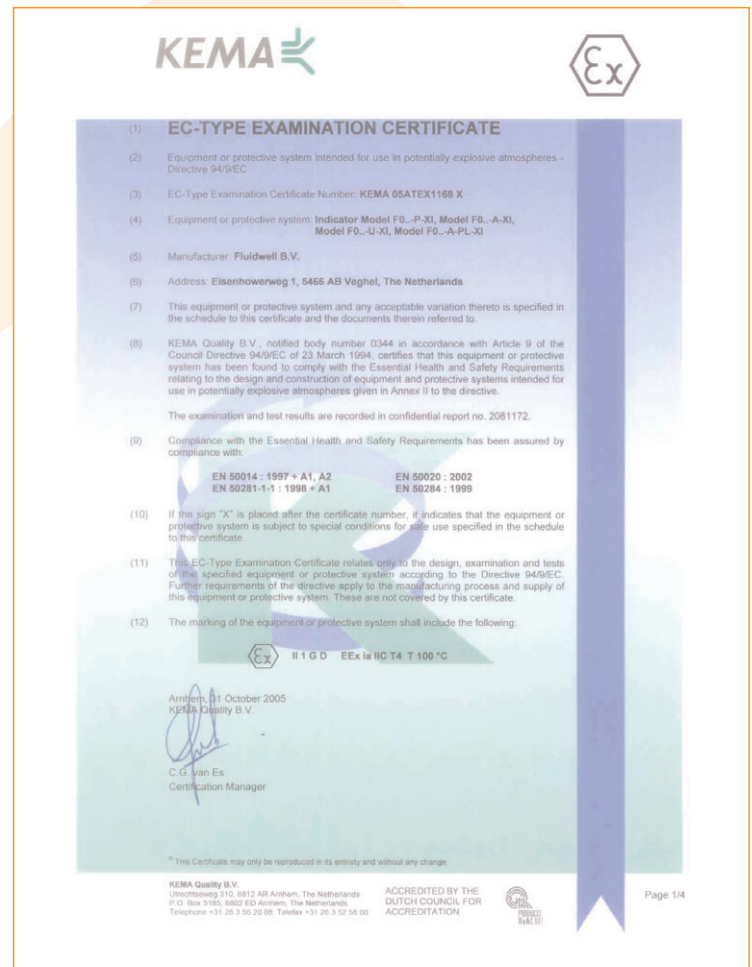

Configuration example IIA - IIB and IIC F030-P-OT-PC-(PX)-XI-(ZB) - Battery powered unit

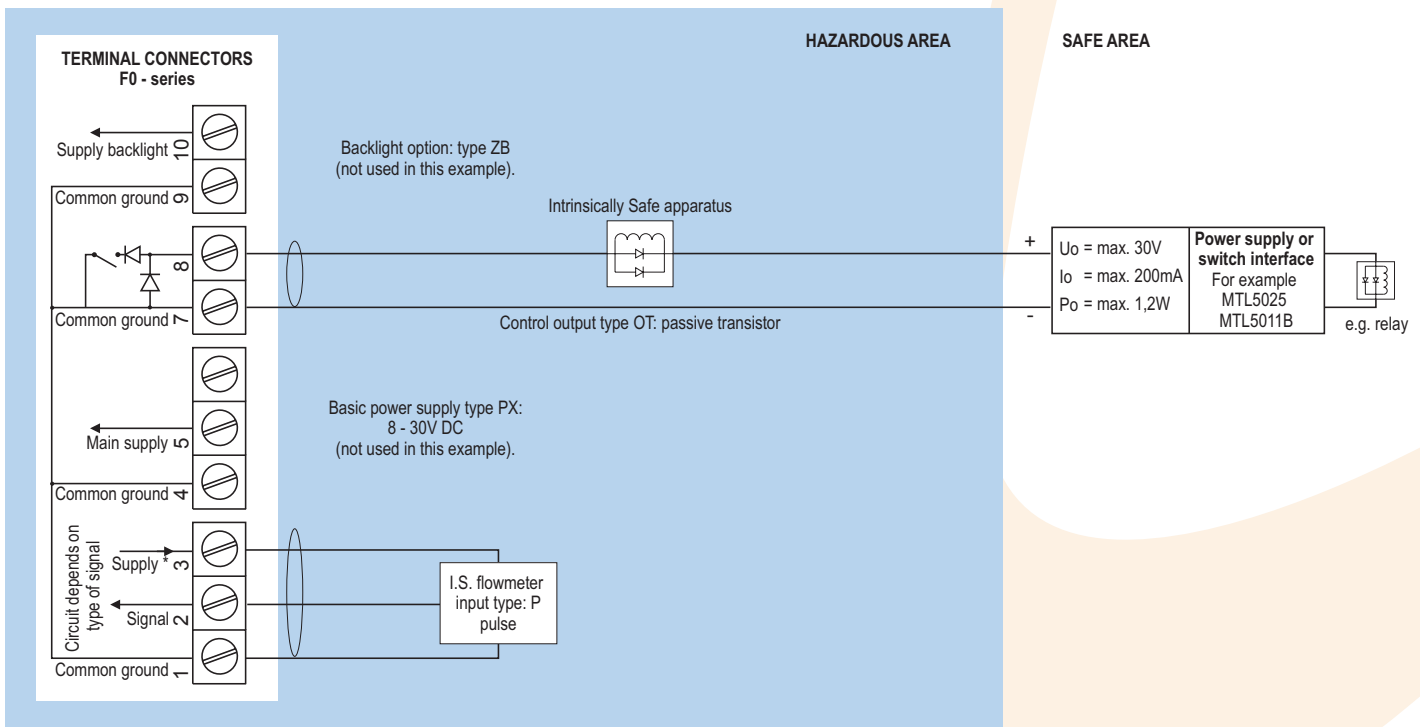

* Sensor supply voltage for pulse flowmeter type P : Terminal 3: 1.2 / 3.2V DC.
Please note: type PX may be used in combination with the battery (type PC). PX will power the unit; the battery will be disabled automatically till power is disconnected.

Configuration example IIA - IIB and IIC - F030-P-OT-PX-XI-(ZB) - Basic power supply 8 - 30V DC

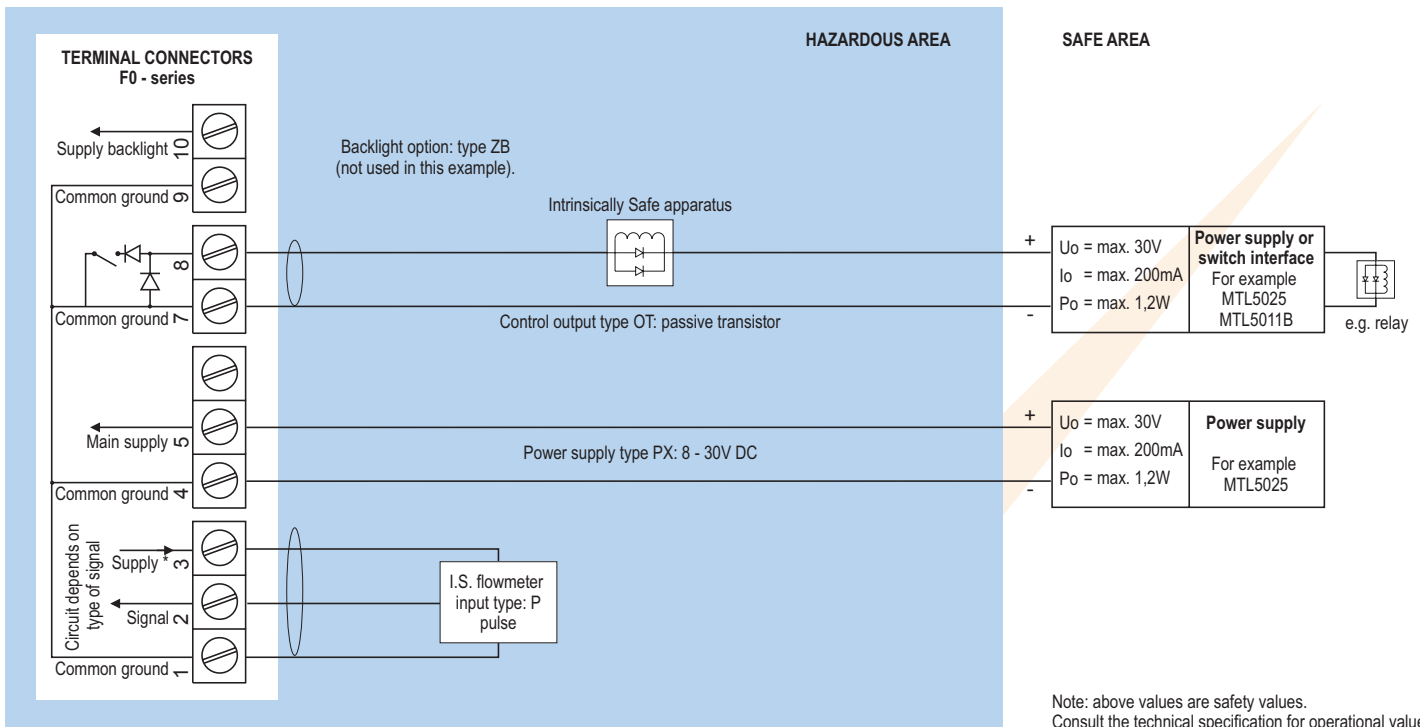

* Sensor supply voltage for pulse type P: Terminal 3: 1.2V / 3.2V DC.

Please note: type PX may be used in combination with the battery (type PC). PX will power the unit; the battery will be disabled automatically till power is disconnected.

Configuration example IIA - IIB and IIC - F030-P-OT-PX-XI-ZB - Basic power supply 8 - 30V DC

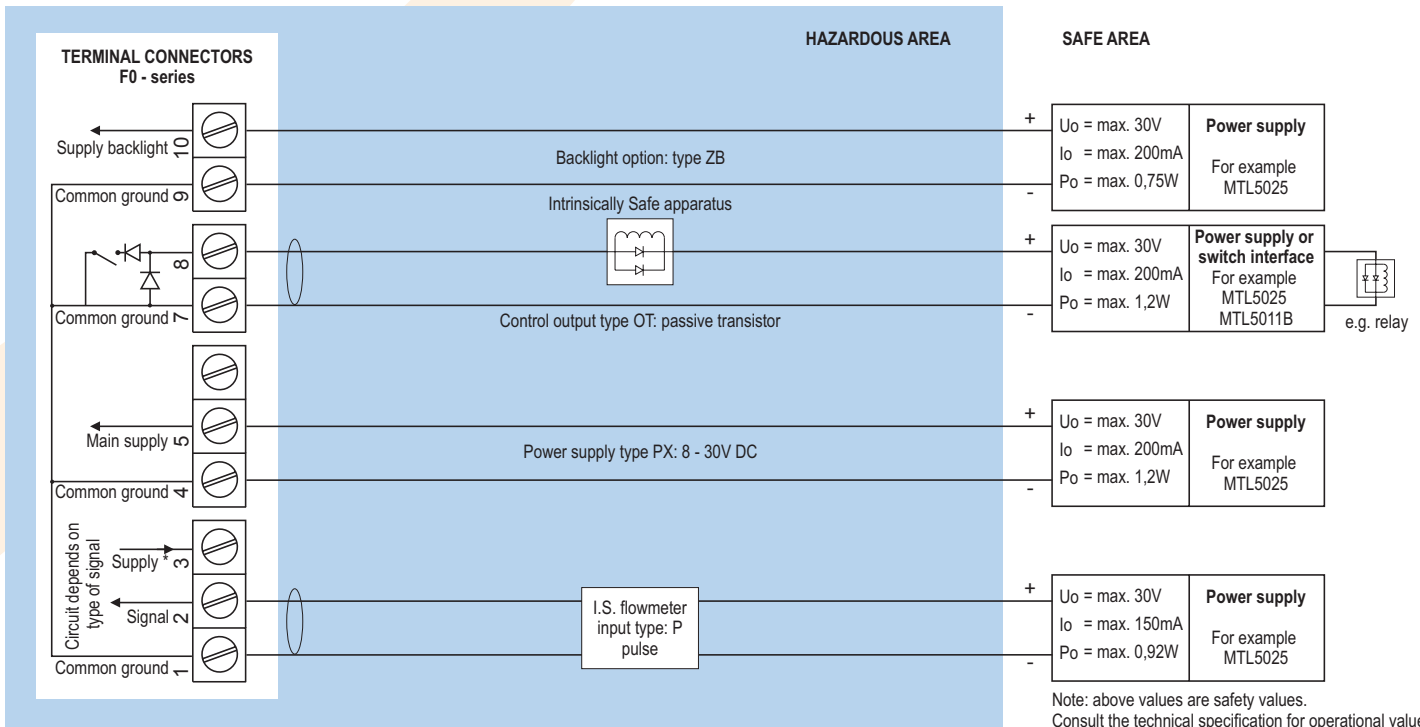

* Sensor supply voltage for pulse type P: Terminal 3: 1.2V / 3.2V DC.

Please note: type PX may be used in combination with the battery (type PC). PX will power the unit; the battery will be disabled automatically till power is disconnected.

Configuration example IIA - IIB and IIC - F030-P-OT-PD-XI-ZB - Power supply 16 - 30V DC

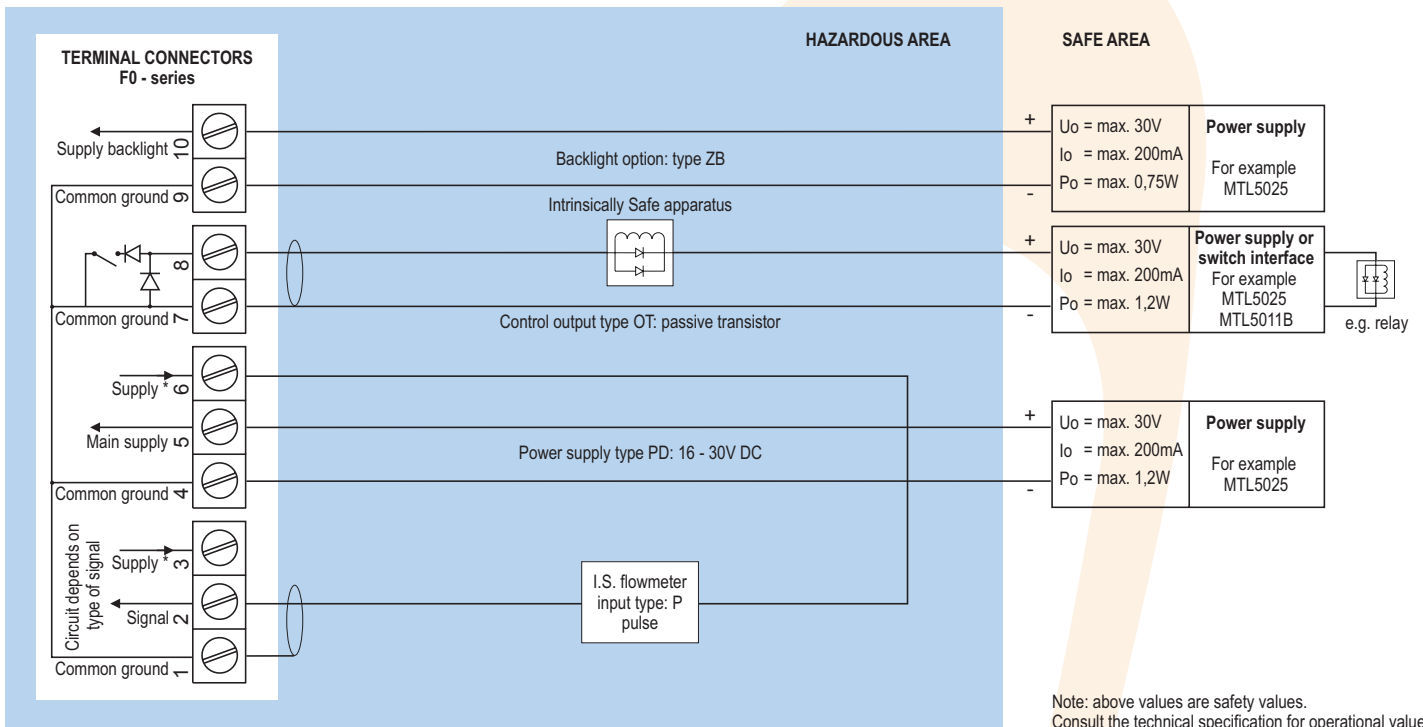

* Sensor supply voltage for pulse type P: Terminal 3: 1.2V / 3.2V DC. Terminal 6: 8.2V DC.

Please note: type PD may be used in combination with the battery (type PC). PD will power the unit; the battery will be disabled automatically till power is disconnected.

Configuration example IIA - IIB and IIC - F030-A-OT-PD-XI-ZB - Power supply 16 - 30V DC

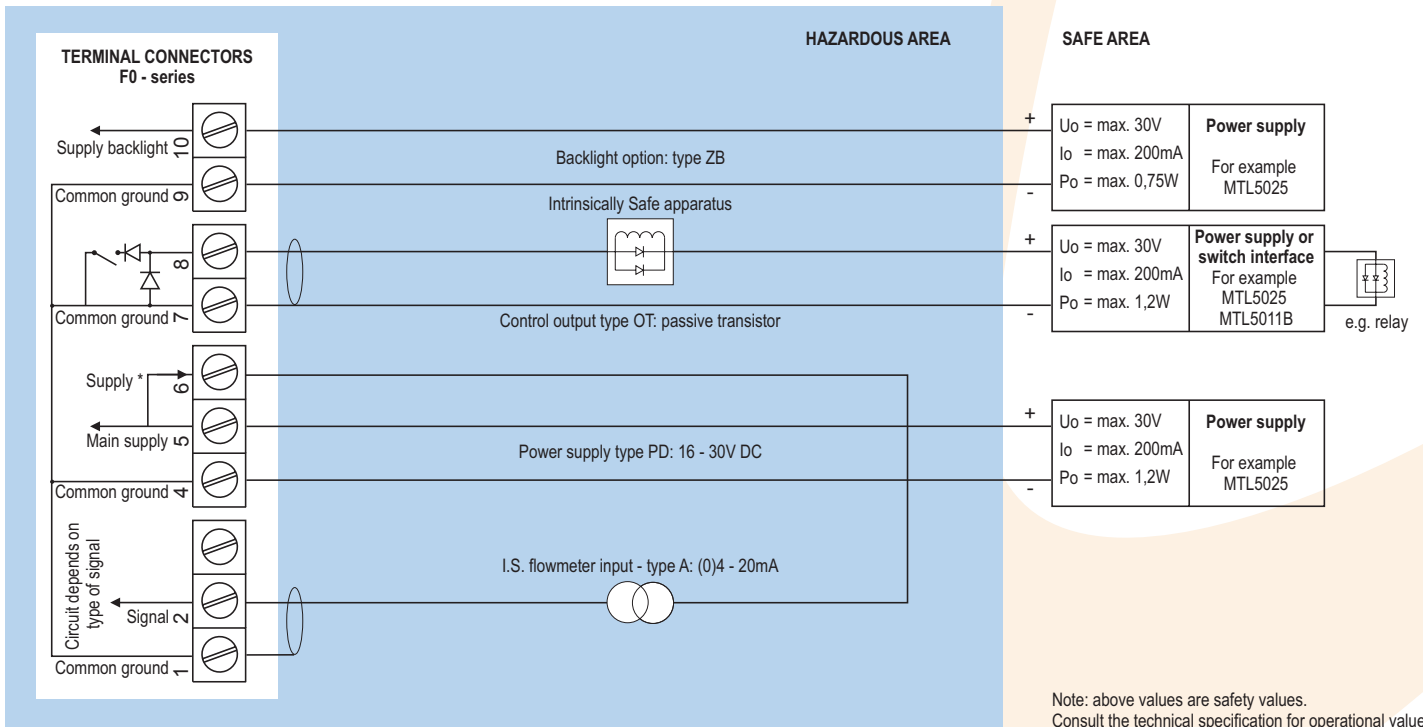

* Sensor supply voltage for analog flowmeter type A / U: Terminal 6: as input voltage terminal 5 (internally linked).

Please note: type PD may be used in combination with the battery (type PC). PD will power the unit; the battery will be disabled automatically till power is disconnected.

Configuration example IIA - IIB and IIC - F030-A-OT-PL-XI-ZB - Input loop powered

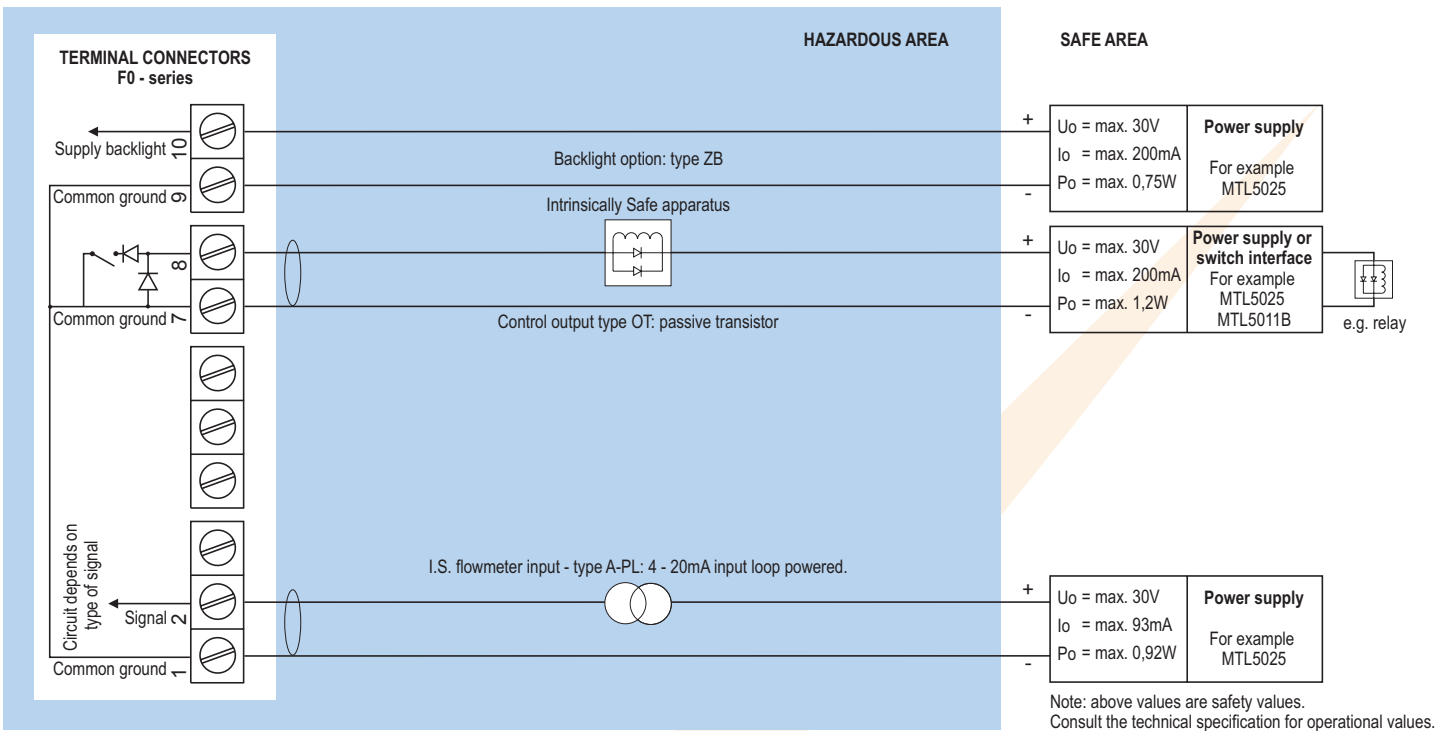

Sensor supply is not available: unit is input loop powered (type PL).
Please note: type PL may be used in combination with the battery (type PC). PL will power the unit; the battery will be disabled automatically till power is disconnected.

Configuration example IIA - IIB and IIC - F030-A-OT-PX-XI-ZB - Basic power supply 8 - 30V DC

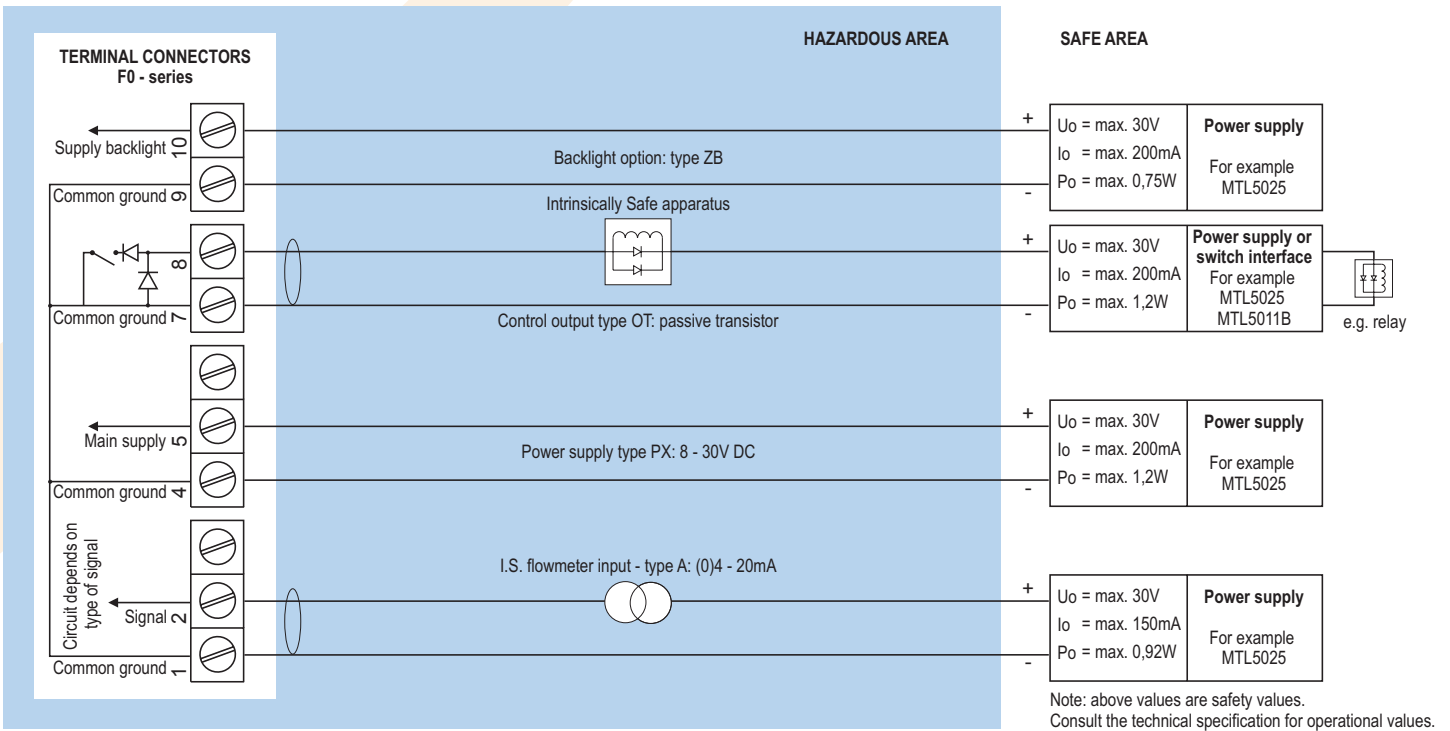

* Sensor supply voltage for analog flowmeter type A / U: not available in this example.
Please note: type PX may be used in combination with the battery (type PC). PX will power the unit; the battery will be disabled automatically till power is disconnected.

Technical specification

General

Display	
Type	High intensity reflective numeric and alphanumeric LCD, UV-resistant.
Dimensions	90 x 40mm (3.5" x 1.6").
Digits	Seven 17mm (0.67") and eleven 8mm (0.31") digits. Various symbols and measuring units.
Refresh rate	User definable: 8 times/sec. - 30 secs - off.
Option ZB	Transflective LCD with bi-color LED-backlight; green / amber. Intensity and color selected through the keyboard. Good readings in full sunlight and darkness. Also available Intrinsically Safe.

Operating temperature

Standard unit	-40°C to +80°C (-40°F to +178°F).
Intrinsically Safe	-40°C to +70°C (-40°F to +158°F).

Power requirements

Type PB	Long life Lithium battery - life-time depends upon settings and configuration - up to 5 years.
Type PC	Intrinsically Safe long life lithium battery - life-time depends upon settings and configuration - up to 5 years.
Type PD	16 - 30V DC. Power consumption max. 1 Watt.
Type PF	24V AC / DC ± 10%. Power consumption max. 15 Watt.
Type PL	Input loop powered from sensor signal 4 - 20mA (type A).
Type PM	115 - 230V AC ± 10%. Power consumption max. 15 Watt.
Type PX	8 - 30V DC. Power consumption max. 0.3 Watt.
Type ZB	20 - 30V DC. Power consumption max. 1 Watt. With type PF / PM: internally powered.
Note PB/PF/PM	Not available Intrinsically Safe.
Note PF/PM	The total consumption of the sensor, active output type OA and backlight type ZB may not exceed 400mA @ 24V DC.
Note	For Intrinsically Safe applications, consult the safety values in the certificate.

Sensor excitation

Type PB/PC/PX	3.2V DC for pulse signals and 1.2V DC for coil pick-up.
Note	This is not a real sensor supply. Only suitable for sensors with a very low power consumption like coils (sine wave) and reed-switches.
Type PD	for pulse signals: 1.2 / 3.2 / 8.2V DC - max. 5mA@8.2V DC. For analog signals, the sensor supply voltage is according to the power supply voltage connected.
Type PF / PM	With pulse input: 1.2 / 3.2 / 8.2 / 12 / 24V DC - max. 400mA @ 24V DC. With analog input: 8.2 / 12 / 24V DC - max. 400mA @ 24V DC.

Terminal connections

Type	Removable plug-in terminal strip. Wire max. 1.5mm ² and 2.5mm ² .
------	--

Data protection

Type	EEPROM backup of all settings. Backup of running totals every minute. Data retention at least 10 years.
Pass-code	Configuration settings can be pass-code protected.

Casing

General

Window	Polycarbonate window.
Sealing	Silicone.
Control keys	Three industrial micro-switch keys. UV-resistant silicone keypad.

Aluminum wall / field mount enclosures

General	Die-cast aluminum wall/field mount enclosure IP67 / NEMA 4X with 2-component UV-resistant coating.
Dimensions	130 x 120 x 75mm (5.12" x 4.72" x 2.95") - W x H x D.
Weight	1100 gr.
Type HA	Cable entry: 2 x PG9 and 1 x M20.
Type HM	Cable entry: 2 x M16 and 1 x M20.
Type HN	Cable entry: 1 x M20.
Type HO	Cable entry: 2 x M20.
Type HP	Cable entry: 6 x M12.
Type HT	Cable entry: 1 x 1/2" NPT.
Type HU	Cable entry: 3 x 1/2" NPT.
Type HZ	Cable entry: no holes.

GRP wall / field mount enclosures

General	GRP wall/field mount enclosure IP67 / NEMA 4X, UV-resistant and flame retardant.
Dimensions	130 x 120 x 75mm (5.12" x 4.72" x 2.95") - W x H x D.
Weight	600 gr.
Type HD	Cable entry: no holes.
Type HE	Cable entry: 2 x Ø 16mm and 1 x Ø 20mm.
Type HF	Cable entry: 1 x Ø 22mm (7/8").
Type HG	Cable entry: 2 x Ø 20mm.
Type HH	Cable entry: 6 x Ø 12mm.
Type HJ	Cable entry: 3 x Ø 22mm (7/8").
Type HK	Flat bottom, cable entry: no holes.

Panel mount enclosures

Dimensions	130 x 120 x 60mm (5.12" x 4.72" x 2.36") - W x H x D.
Panel cut-out	115 x 98mm (4.53" x 3.86") L x H.
Type HB	Die-cast aluminum panel mount enclosure IP65 / NEMA 4.
Weight	600 gr.
Type HC	GRP panel mount enclosure IP65 / NEMA 4, UV-resistant and flame retardant.
Weight	450 gr.

ABS wall / field mount enclosures

General	Silicone free ABS wall/field mount enclosure IP65 with EPDM and PE sealings. UV-resistant polyester keypad (old HD enclosure).
Dimensions	130 x 114 x 71mm (5.1" x 4.5" x 2.8") - W x H x D.
Weight	450 gr.
Type HS	Cable entry: no holes.

Hazardous area

Intrinsically Safe

ATEX certification	Ⓔ II 1 GD EEx ia IIC T4 T100°C
CSA C-US/IECEX certification	IECEX, CSA and FM approvals are expected to become available in autumn 2008.
Ambient	-40°C to +70°C / -40° to +158°F.

Explosion proof

ATEX certification	Ⓔ II 2 GD EEx d IIB T5.
Type XF	Dimensions of enclosure: 300 x 250 x 200mm (11.8" x 9.9" x 7.9") L x H x D.
Weight	Appr. 15kg.

Environment

Electromagnetic compatibility	Compliant ref: EN 61326 (1997), EN 61010-1 (1993).
-------------------------------	--

Signal input

Flowmeter sensor

Type P	Coil / sine wave (minimum 20mVpp or 80mVpp - sensitivity selectable), NPN/PNP, open collector, reed-switch, Namur, active pulse signals 8 - 12 and 24V DC.
Frequency	Minimum 0Hz - maximum 7kHz for total and flow rate. Maximum frequency depends on signal type and internal low-pass filter. E.g. reed switch with low-pass filter: max. frequency 120Hz.
K-Factor	0.000010 - 9,999,999 with variable decimal position.
Low-pass filter	Available for all pulse signals.
Option ZF	coil sensitivity 10mVpp.
Option ZG	coil sensitivity 5mVpp.
Type A	(0)4 - 20mA. Analog input signal can be scaled to any desired range within 0 - 20mA.
Type U	0 - 10V DC. Analog input signal can be scaled to any desired range within 0 - 10V DC.
Accuracy	Resolution: 16 bit. Error < 0.01mA / ± 0.05% FS. Low level cut-off programmable.
Span	0.001 / 999,999 with variable decimal position.
Update time	Four times per second.
Voltage drop	Type A: max. 2V DC @ 20mA.
Voltage drop	Type A - PL (loop powered): max. 2.6V DC @ 20mA.
Load impedance	Type U: 3kΩ.
Relationship	Linear and square root calculation.
Note	For signal type A and U: external power to sensor is required; e.g. type PD.

Signal output

Control output

Function	Control output according the batch process.
Type OA	One active 24V DC transistor output (PNP); load max. 400mA (requires PF or PM).
Type OR	One electro-mechanical relay output - isolated; max. switch power 230V AC (N.O.) - 0.5A (requires PF or PM).
Type OT	One passive transistor output (NPN) - not isolated. Max. 50V DC - 300mA per output.

Operational

Operator functions

Displayed functions	<ul style="list-style-type: none"> • Preset value - can be entered by the operator. • Batched quantity or remaining quantity. • Total and accumulated total. • Total can be reset to zero by pressing the STOP-key twice.
---------------------	---

Preset and total

Digits	7 digits.
Units	L, m ³ , GAL, USGAL, KG, lb, bbl, no unit.
Decimals	0 - 1 - 2 or 3.
Note	Total can be reset to zero.

Accumulated total

Digits	11 digits.
Units / decimals	According to selection for total.
Note	Can not be reset to zero.

Accessories

Mounting accessories

ACFo2	Stainless steel wall mounting kit.
ACFo5	Stainless steel pipe mounting kit (worm gear clamps not included).
ACFo6	Two stainless steel worm gear clamps Ø 44 - 56mm.
ACFo7	Two stainless steel worm gear clamps Ø 58 - 75mm.
ACFo8	Two stainless steel worm gear clamps Ø 77 - 95mm.
ACFo9	Two stainless steel worm gear clamps Ø 106 - 138mm.
ACFo10	Customized Grevopal tagplates for ACFo2 and ACFo5, including stainless steel screws. Dimension: 95mm x 12.5mm (3.75" x 0.50").

Cable gland accessories

ACF20	For HA enclosure, includes O-rings.
ACF25	For HE enclosure, includes locknuts and O-rings.
ACF26	For HF enclosure, includes locknuts and O-rings.
ACF27	For HG enclosure, includes locknuts and O-rings.
ACF28	For HH enclosure, includes locknuts and O-rings.
ACF29	For HJ enclosure, includes locknuts and O-rings.
ACF32	For HM enclosure, includes O-rings.
ACF33	For HN enclosure, includes O-rings.
ACF34	For HO enclosure, includes O-rings.
ACF35	For HP enclosure, includes O-rings.
ACF39	For HT enclosure, includes O-rings.
ACF40	For HU enclosure, includes O-rings.

Display example - 90 x 40mm (3.5" x 1.6")

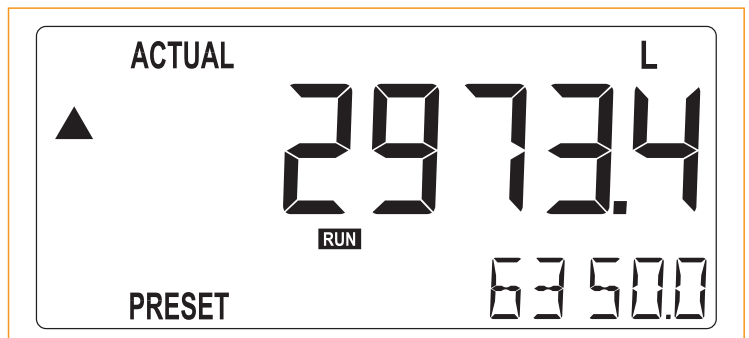

Ordering information

Standard configuration: F030-P-HC-OT-PX-XX-ZX.

ordering information:	F030	-	-H	-O	-P	-X	-Z
Flowmeter/Pressure/Level/Temperature/Sensor input signal							
A	⊗ (o)4 - 20mA input.						
P	⊗ Pulse input: coil, npn, pnp, namur, reed-switch.						
U	⊗ 0 - 10V DC input.						
Panel mount enclosures - IP65 / NEMA4							
HB	⊗ Aluminum enclosure.						
HC	⊗ GRP enclosure.						
GRP field / wall mount enclosures - IP67 / NEMA4X							
HD	⊗ Cable entry: no holes.						
HE	⊗ Cable entry: 2 x Ø 16mm & 1 x Ø 20mm.						
HF	⊗ Cable entry: 1 x Ø 22mm (7/8").						
HG	⊗ Cable entry: 2 x Ø 20mm.						
HH	⊗ Cable entry: 6 x Ø 12mm.						
HJ	⊗ Cable entry: 3 x Ø 22mm (7/8").						
HK	⊗ Flat bottom, cable entry: no holes.						
Aluminum field / wall mount enclosures - IP67 / NEMA4X							
HA	⊗ Cable entry: 2 x PG9 + 1 x M20.						
HM	⊗ Cable entry: 2 x M16 + 1 x M20.						
HN	⊗ Cable entry: 1 x M20.						
HO	⊗ Cable entry: 2 x M20.						
HP	⊗ Cable entry: 6 x M12.						
HT	⊗ Cable entry: 1 x 1/2" NPT.						
HU	⊗ Cable entry: 3 x 1/2" NPT.						
HZ	⊗ Cable entry: no holes.						
ABS field / wall mount enclosures							
HS	⊗ Silicone free ABS field enclosure IP65 – Cable entry: no holes (old HD enclosure).						
Output							
OA	One active transistor output - requires PF or PM.						
OR	One mechanical relay output - requires PF or PM.						
OT	⊗ One passive transistor output - standard configuration.						
Power supply							
PB	Lithium battery powered.						
PC	⊗ Lithium battery powered - Intrinsically Safe.						
PD	⊗ 16 - 30V DC + sensor supply.						
PF	24V AC / DC + sensor supply.						
PL	⊗ Input loop powered from sensor signal type "A".						
PM	115 - 230V AC + sensor supply.						
PX	⊗ Basic power supply 8 - 30V DC (no real sensor supply).						
Hazardous area							
XI	⊗ Intrinsically Safe.						
XF	EExd enclosure - 3 keys.						
XX	Safe area only.						
Other options							
ZB	⊗ Backlight.						
ZF	⊗ Coil input 10mVpp.						
ZG	⊗ Coil input 5mVpp.						
ZX	⊗ No options.						

The bold marked text contains the standard configuration.

⊗ Available Intrinsically Safe.

Specifications are subject to change without notice.

FLUIDWELL bv
P.O. Box 6
5460 AA - Veghel - The Netherlands
Tel.: +31 (0)413 343786
Fax.: +31 (0)413 363443
sales@fluidwell.com
Internet: www.fluidwell.com

